

ES-SYSTEM

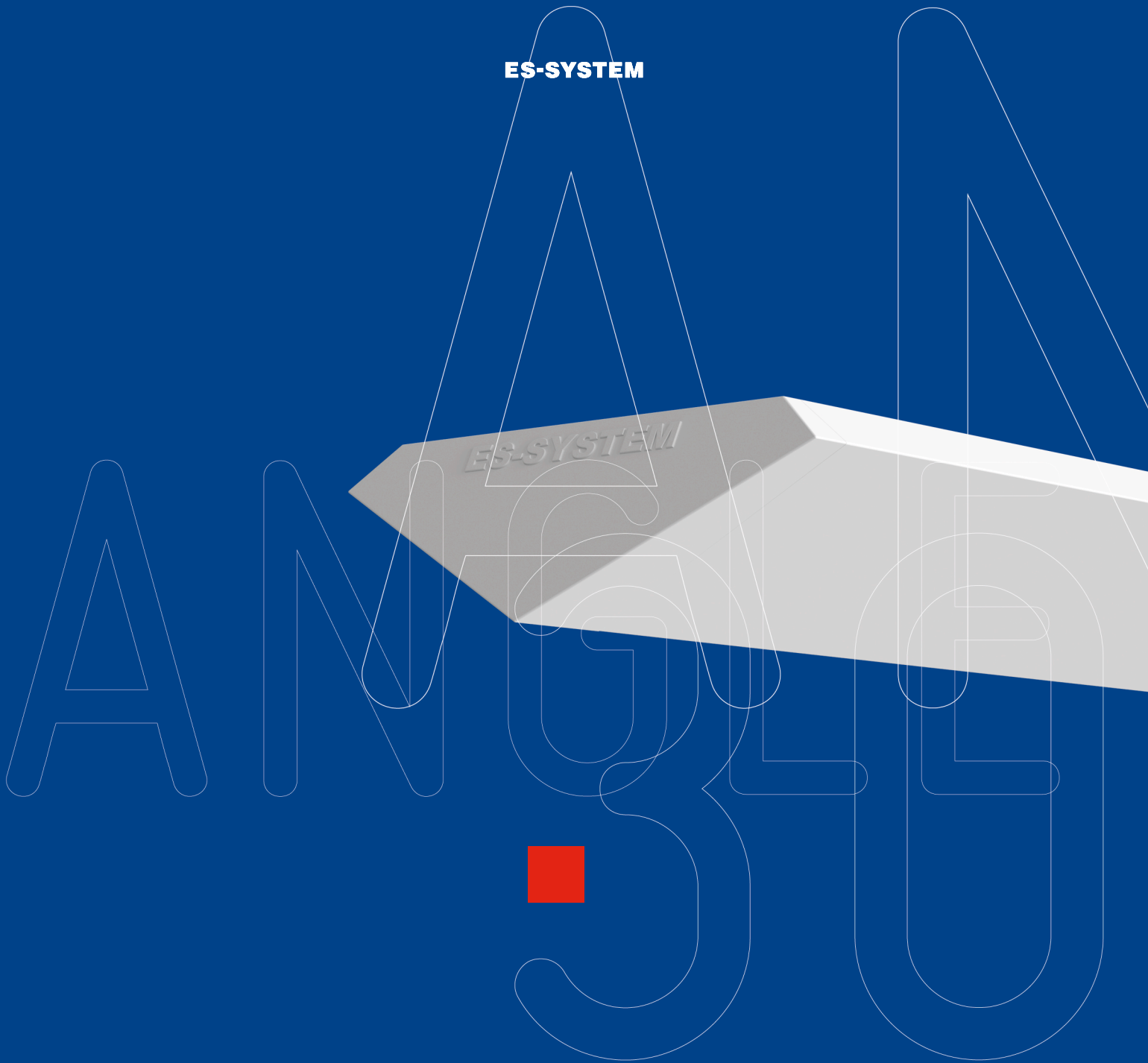

system

ANGLE 30

# ANGLE 30

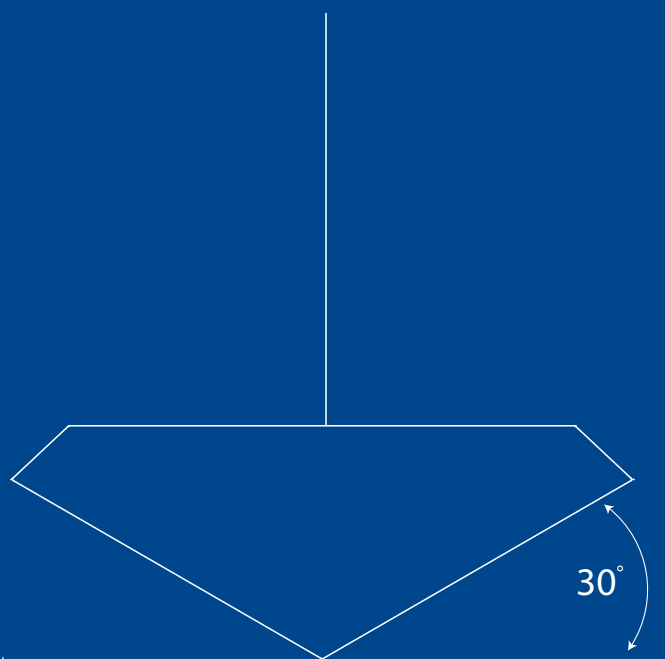

Design – Thorén & Bylund



Bilder och specifikationer på produkterna i denna katalog gäller endast kommersiell information. Enligt lag utgör de inget bindande erbjudande. Vissa parametrar på de levererade produkterna (speciellt deras vikt och färegenskaper) kan skilja sig från exemplen i denna katalog. Även produkternas utseende kan skilja sig något från fotografier och ritningar som finns i katalogen. ES-SYSTEM förbehåller sig rätten att ta bort produkter från denna katalog eller ändra deras parametrar.

Pictures and parameters of the products included in this catalogue contain commercial information that, according to the law regulations, are not a trade offer. Some parameters of delivered products (and especially weights or colours) may differ from the examples shown in this catalogue. Also, the look of the products may slightly differ from the photographs and drawings presented. ES-SYSTEM S.A. reserves its rights to withdraw some products from the catalogue or modify their parameters.

Zdjęcia i parametry produktów zawarte w niniejszym katalogu stanowią jedynie informację handlową i nie są ofertą w rozumieniu prawa. Niektóre parametry dostarczanych produktów (w szczególności waga lub kolor) mogą się różnić od parametrów produktów wskazanych w niniejszym katalogu. Wygląd produktów może nieznacznie odbiegać od zdjęć i rysunków prezentowanych w niniejszym katalogu. ES-SYSTEM S.A. zastrzega sobie prawo wycofania produktów z niniejszego katalogu lub zmiany ich parametrów.

# ANGLE 30

Den indirekta belysningens roll får allt större betydelse, inte bara på grund av dess funktionella fördelar, men också tack vare de möjligheter den erbjuder för att skapa den individuella karaktären av varje utrymme och betona dess unika.

En harmonisk blandning av fördelar ligger i enkelheten av Thorén & Bylund:s ANGLE armaturdesign. Den minimalistiska formen i kombination med avancerad teknik gör det speciella belysningssystemet verkligen exceptionellt.

The role of indirect lighting is increasingly gaining importance, not only due to its functional advantages, but also thanks to the possibilities it offers in creating the individual character of each space and emphasizing its uniqueness.

A harmonious blend of benefits lies in the simplicity of Thorén & Bylund's ANGLE luminaire design. Its minimalist form combined with the advanced technology it incorporates makes this particular lighting system truly exceptional.

Rola oświetlenia pośredniego jest coraz bardziej doceniana nie tylko ze względu na jego walory użytkowe, lecz również możliwości jakie daje ono w tworzeniu indywidualnego charakteru każdego obiektu podkreślając jego niepowtarzalność. Harmonijne połączenie zalet prostego designu oprawy ANGLE zaprojektowanej przez Thorén & Bylund, jej minimalistycznej formy (wzornictwa) wraz z zastosowaną zaawansowaną technologią i szerokimi możliwościami jej wykorzystania, stanowi o wyjątkowości systemu.



system

# ANGLE 30



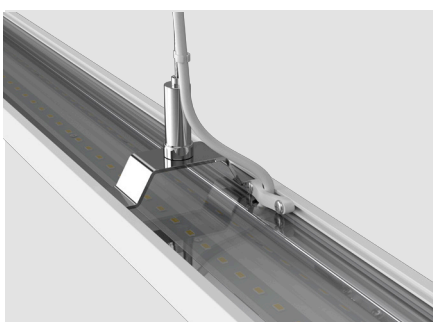
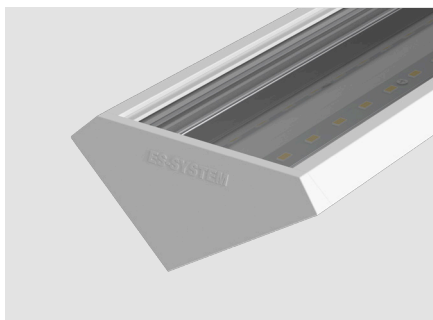

system

# ANGLE 30

## Pendlad armatur

STOMME: lackerad aluminiumprofil  
 DIFFUSÖR: transparent PC  
 LJUSKÄLLA: LED-modul, livslängd: 50 000 driftstimmar, CRI >80, SDCM 3  
 STRÖMFÖRSÖRJNING: elektroniskt driftdon integrerat i takkopp  
 ÖVRIGA: takkopp, 1,5 m wireupphäng med strömkabel och monteringsfästen

## Pendant luminaire

BODY: painted aluminum profile  
 DIFFUSER: transparent PC  
 LIGHT SOURCE: LED-module, 50 000 h life time, CRI>80, SDCM 3  
 POWER SUPPLY: electronic driver installed inside the ceiling canopy  
 OTHER: delivered with a 1.5 m power cable and suspension wires and ceiling canopy

## Oprawa zwieszana

OBUDOWA: profil aluminiowy, lakierowany  
 DYFUZOR: PC, przezroczysty  
 ŹRÓDŁO: moduł LED, trwałość eksploatacyjna ponad 50 000 godzin pracy, CRI >80, SDCM3  
 ZASILACZ: elektroniczny, wewnątrz podsufitki  
 INNE: podsufitka, przewód zasilający i zwieszaki o długości 1,5 m w komplecie z oprawą

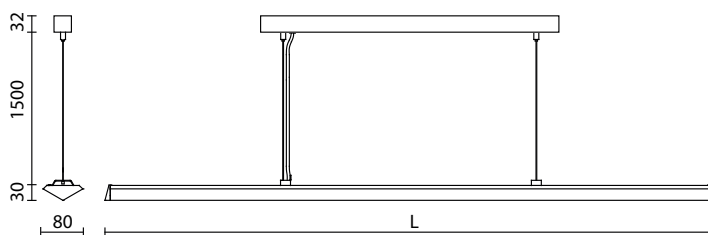

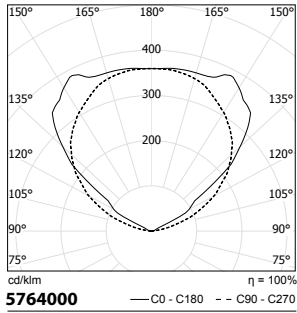
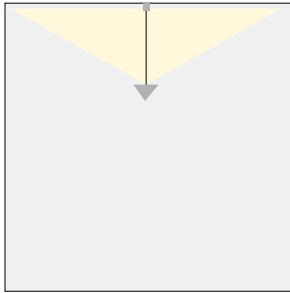

# ANGLE 30 system

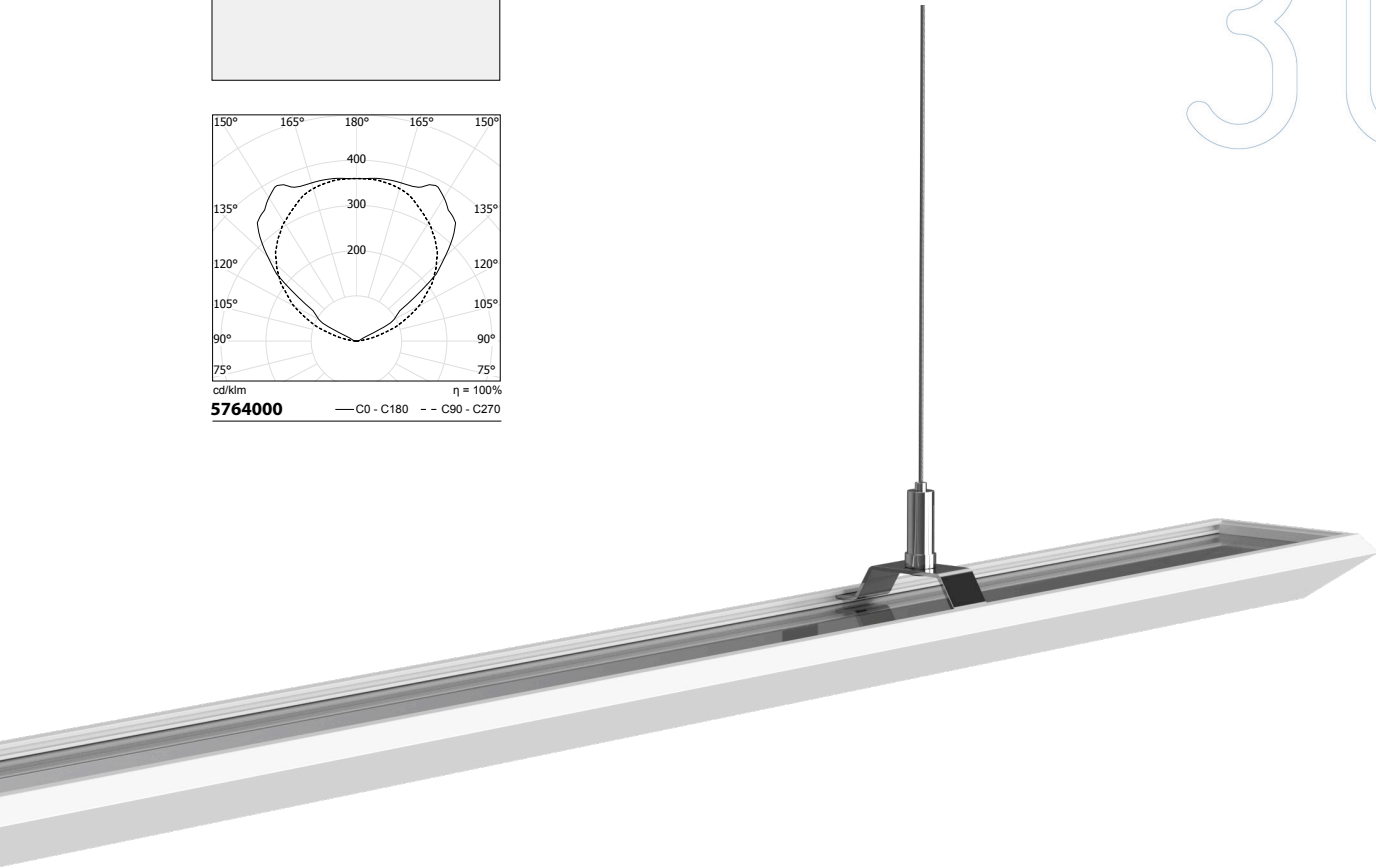

	L [mm]
ANGLE 30 625	525
ANGLE 30 1225	1025
ANGLE 30 1825	1525
ANGLE 30 2425	2025



Product Code	Model	LED Type	Light Output [lm]	Power [W]	Voltage [V]	Length [m]
5764070	ANGLE 30 525	LED830	3630lm	30W	230V AC	1,60
5764170	ANGLE 30 525	LED840	3630lm	30W	230V AC	1,60
5764270	ANGLE 30 1025	LED830	7260lm	60W	230V AC	2,50
5764370	ANGLE 30 1025	LED840	7260lm	60W	230V AC	2,50
5764470	ANGLE 30 1525	LED830	10890lm	90W	230V AC	3,50
5764570	ANGLE 30 1525	LED840	10890lm	90W	230V AC	3,50
5764670	ANGLE 30 2025	LED830	14520lm	120W	230V AC	5,00
5764770	ANGLE 30 2025	LED840	14520lm	120W	230V AC	5,00

.....?. 0 - ON/OFF • 6 - DALI

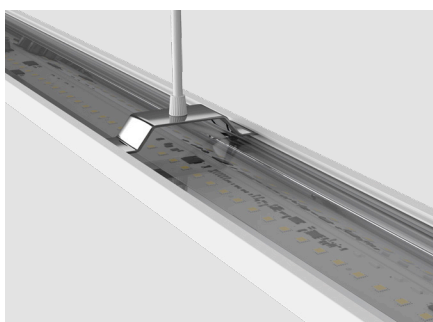
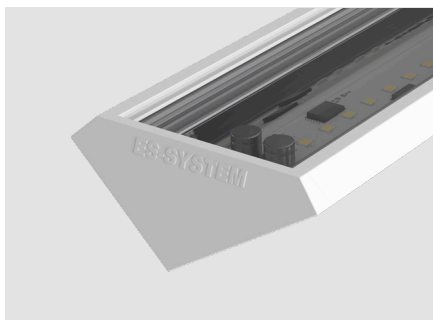

system

# ANGLE 30

## Pendlad armatur

STOMME: lackerad aluminiumprofil  
 DIFFUSÖR: transparent PC  
 LJUSKÄLLA: LED-modul, livslängd: 50 000  
 driftstimmar, CRI >80, SDCM 3  
 STRÖMFÖRSÖRJNING: elektroniskt driftdon integrerat  
 i LED-modulen  
 ÖVRIGA: levereras med 1,5 m strömkabel och  
 monteringsfästen; wireupphäng beställs separat

## Pendant luminaire

BODY: painted aluminum profile  
 DIFFUSER: transparent PC  
 LIGHT SOURCE: LED-module, 50 000 h life time,  
 CRI>80, SDCM 3  
 POWER SUPPLY: electronic driver integrated with the  
 LED module  
 OTHER: delivered with a 1.5 m power cable and suspen-  
 sion bracket; suspension to be ordered separately

## Oprawa zwieszana

OBUDOWA: profil aluminiowy, lakierowany  
 DYFUZOR: PC, przezroczysty  
 ŹRÓDŁO: moduł LED, trwałość eksploatacyjna ponad  
 50 000 godzin pracy, CRI >80, SDCM3  
 ZASILACZ: elektroniczny, zintegrowany  
 z modulem LED  
 INNE: uchwyty mocujące i przewód zasilający  
 o długości 1,5 m w zestawie z oprawą; zwieszak  
 zamawiany oddzielnie

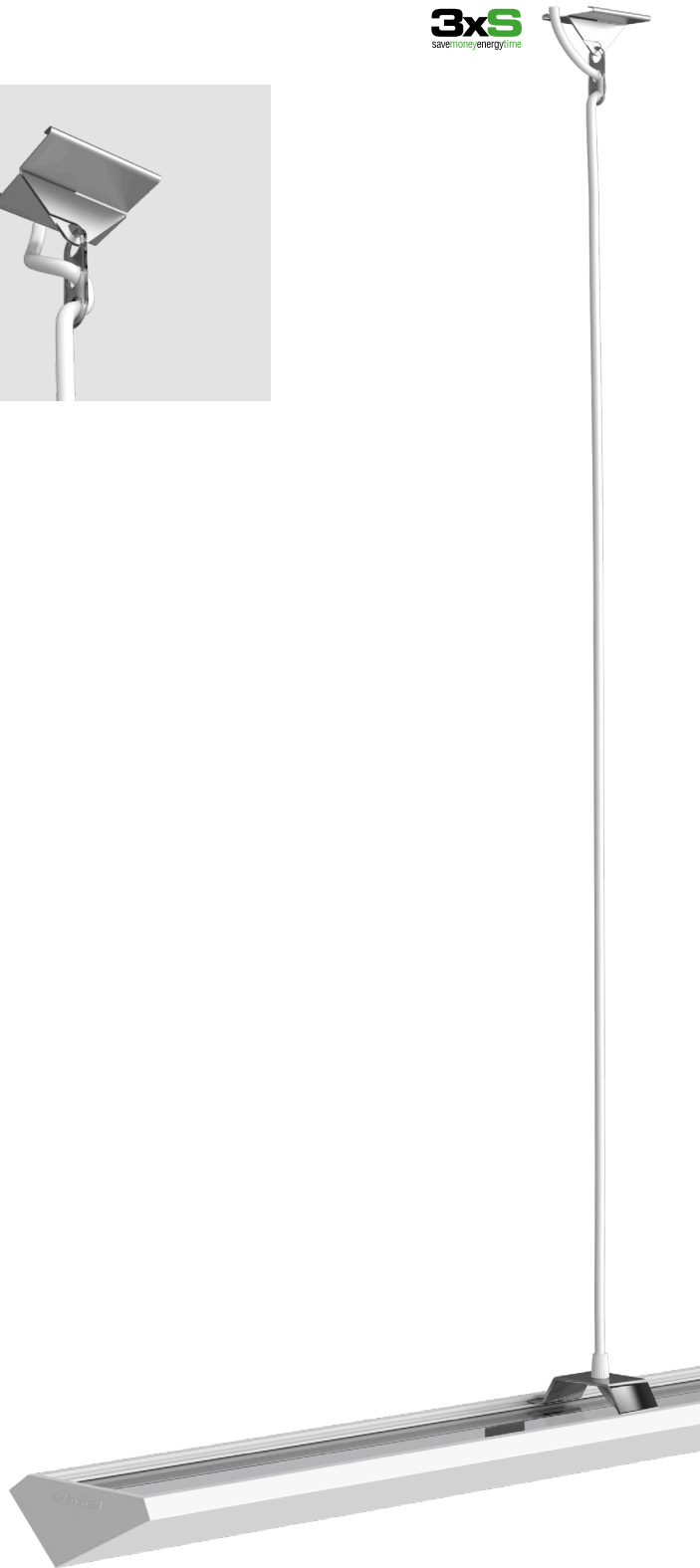
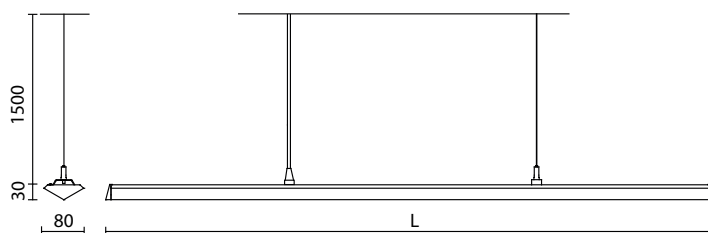



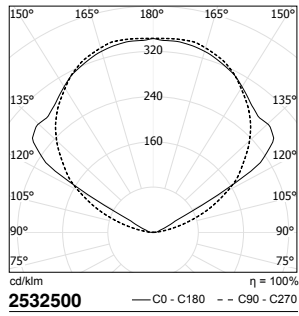
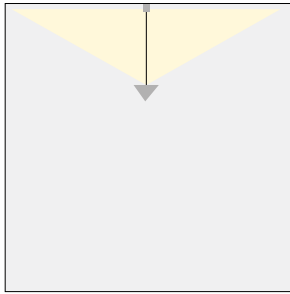

# ANGLE 30 system

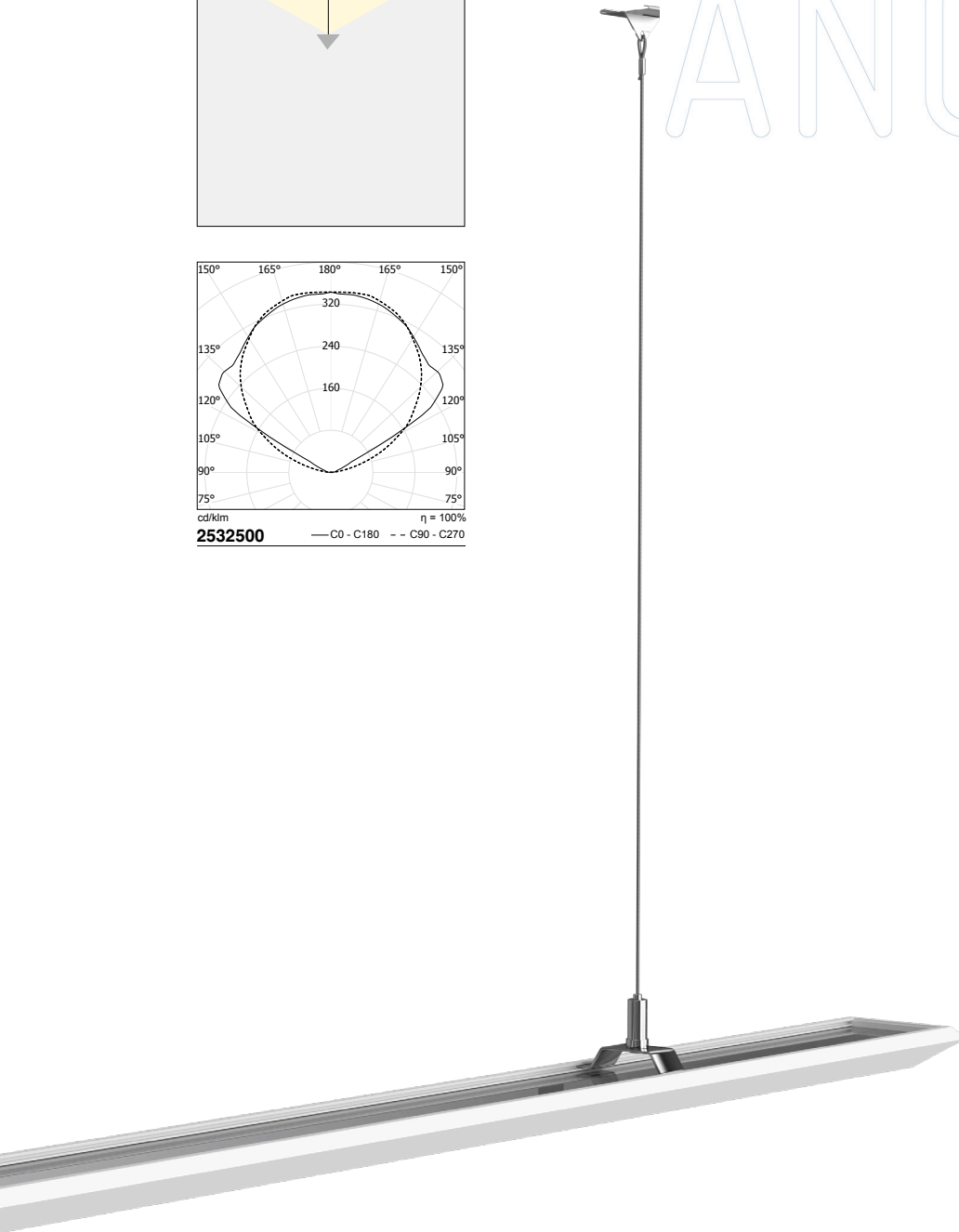

	L [mm]
ANGLE 30 1025	1025
ANGLE 30 2025	2025

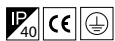

<b>2532500</b>	ANGLE 30 1025	LED 830	4500lm	45W	230V AC	3,50
<b>2532510</b>	ANGLE 30 1025	LED 840	4500lm	45W	230V AC	3,50
<b>2532600</b>	ANGLE 30 2025	LED 830	8900lm	87W	230V AC	6,50
<b>2532610</b>	ANGLE 30 2025	LED 840	8900lm	87W	230V AC	6,50

Tillbehör • Accessories • Akcesoria

9173015 enkelt wireupphäng • suspension wire • zwieszak linkowy pojedynczy

9225015 wireupphäng med ögla • suspension wire with a loop • zwieszak linkowy zakończony pętelką

system

# ANGLE 30







system

# ANGLE 30

## Väggmonterad armatur

STOMME: lackerad aluminiumprofil  
 DIFFUSÖR: transparent PC  
 LJUSKÄLLA: LED-modul, livslängd: 50 000  
 driftstimmar, CRI>80, SDCM 3  
 STRÖMFÖRSÖRJNING: elektroniskt driftdon  
 integrerat i LED-modulen

## Wall-mounted luminaire

BODY: painted aluminum profile  
 DIFFUSER: transparent PC  
 LIGHT SOURCE: LED-module, 50 000 h life time,  
 CRI>80, SDCM 3  
 POWER SUPPLY: electronic driver integrated  
 with the LED module

## Oprawa naścienna

OBUDOWA: profil aluminiowy, lakierowany  
 DYFUZOR: PC, przezroczysty  
 ŹRÓDŁO: moduł LED, trwałość eksploatacyjna  
 ponad 50 000 godzin pracy, CRI >80, SDCM3  
 ZASILACZ: elektroniczny, zintegrowany  
 z modulem LED

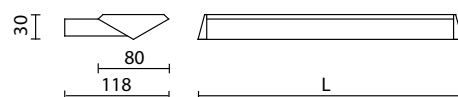

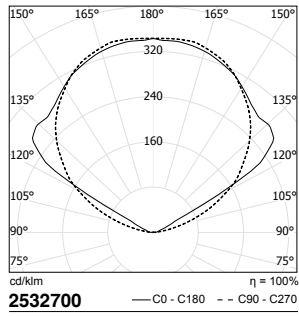
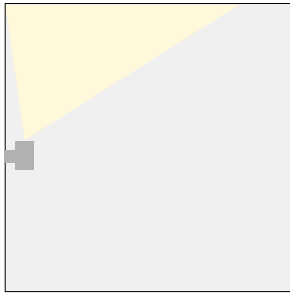

# ANGLE system

# 30

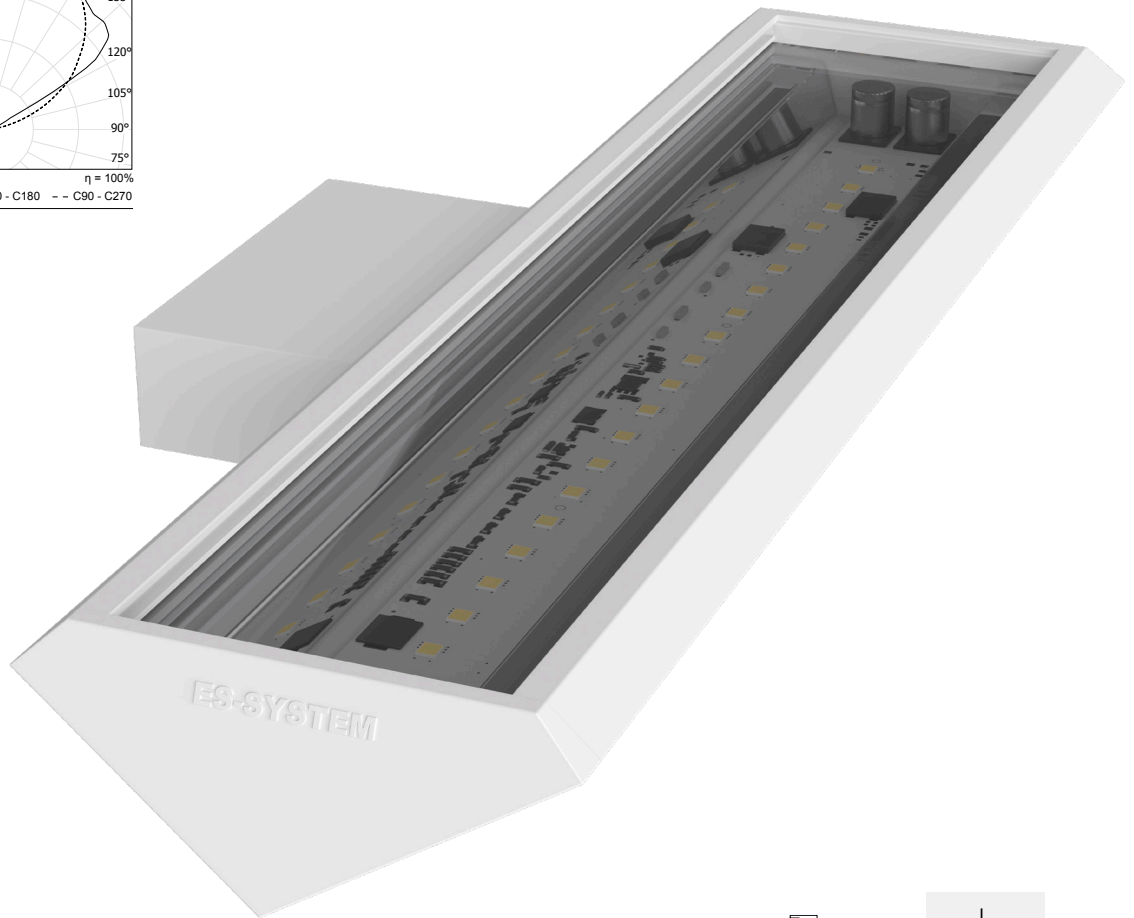

	L [mm]
ANGLE 30 525 WALL	525
ANGLE 30 1005 WALL	1025

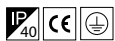

<b>2532700</b>	ANGLE 30 525 WALL	LED830	2200lm	23W	230V AC	3,50
<b>2532710</b>	ANGLE 30 525 WALL	LED840	2200lm	23W	230V AC	3,50
<b>2532800</b>	ANGLE 30 1005 WALL	LED830	4500lm	45W	230V AC	4,50
<b>2532810</b>	ANGLE 30 1005 WALL	LED840	4500lm	45W	230V AC	4,50



## **ES-SYSTEM S.A.**

30-701 KRAKÓW, ul. Przemysłowa 2  
tel. +48 12 656 36 33, +48 12 295 80 00  
fax +48 12 656 36 49  
essystem@essystem.pl

### **ODDZIAŁ GDAŃSK**

80-435 GDAŃSK ul. Biała 1  
tel. 58 345 23 45, fax 58 341 91 11  
gdansk@essystem.pl

### **ODDZIAŁ ŁÓDŹ**

91-072 ŁÓDŹ ul. Legionów 93/95  
tel. 42 633 60 13, fax 42 633 58 67  
lodz@essystem.pl

### **ODDZIAŁ MAZURY**

11-500 Giżycko, Wilkasy ul. Olsztyńska 2  
tel. 87 429 96 30-38, fax 87 429 96 02  
mazury@essystem.pl

### **ODDZIAŁ POZNAŃ**

61-894 POZNAŃ ul. Niezłomnych 1a  
tel. 61 851 80 89, fax 61 851 76 80  
poznan@essystem.pl

### **ODDZIAŁ RZESZÓW**

35-307 RZESZÓW Al. Armii Krajowej 80  
tel. 17 850 82 85, fax 17 850 82 86  
rzeszow@essystem.pl

### **ODDZIAŁ ŚLĄSK**

44-100 GLIWICE ul. Wincentego Pola 16  
tel. 32 339 31 56, fax 32 339 31 55  
slask@essystem.pl

### **ODDZIAŁ WARSZAWA**

03-301 WARSZAWA ul. Jagiellońska 78  
tel. 22 334 63 30 do 35, fax 22 334 63 36  
warszawa@essystem.pl

### **ODDZIAŁ WROCŁAW**

52-315 WROCŁAW ul. Kobierzycka 18  
tel. 71 782 82 98, fax 71 783 29 23  
wroclaw@essystem.pl

## **SPÓŁKA ZAGRANICZNA FOREIGN SUBSIDIARY**

### **ES-SYSTEM SCANDINAVIA AB**

Klarabergsviadukten 92  
111 64 Stockholm  
tel. +46 (0)8 585 000 35  
fax +46 (0)8 585 000 45  
www.essystem.se  
info@essystem.se