



Źródła światła

LIGHT SOURCES | LICHTQUELLE |
ИСТОЧНИКИ СВЕТА | SVĚTELNÉ ZDROJE

HALOGEN LIGHTING SOURCES 12V
 HALOGENGLÜHLAMPE 12V
 ГАЛОГЕННЫЕ ЛАМПЫ 12V
 HALOGENOVÁ ŽÁROVKA 12V



żarnik zasilany 12VAC (zasilacz halogenowy)



do montażu z gniazdami G4 oraz G6.35

JCG4-10



JCG635-20









TRWAŁOŚĆ ► 2000h

LIFE ► 2000h

LEBENSDAUER ► 2000h

СРОК СЛУЖБЫ ► 2000 ч

Životnost ► 2000h

					
kod	symbol	EAN	opakowanie	moc [W]	strumień świetlny [lm]
D00-JCG4-05	JCG4-05	5908311360248	100/1000	5	60
D00-JCG4-10	JCG4-10	5908311360255	100/1000	10	130
D00-JCG4-20	JCG4-20	5908311360262	100/1000	20	300
D00-JCG4-35	JCG4-35	5908311360279	100/1000	35	500
D00-JCG635-20	JCG635-20	5908311360286	100/1000	20	320
D00-JCG635-35	JCG635-35	5908311360293	100/1000	35	630
D00-JCG635-50	JCG635-50	5908311360309	100/1000	50	950

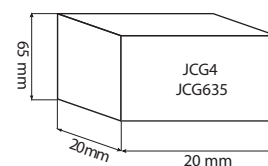
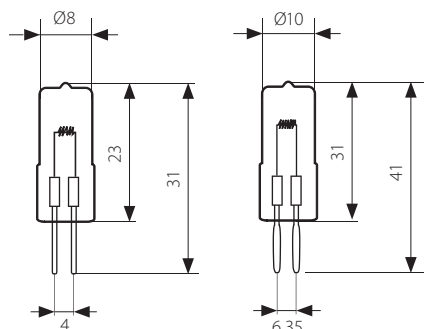

12V

G6,35

G4

3000K

AR111

HALOGEN LIGHTING SOURCES 12V
HALOGENGLÜHLAMPE 12V
ГАЛОГЕННАЯ ЛАМПА 12В
DICHROICKÝ HALOGEN 12V



widok wnętrza lampy ze szklanym odbłyśnikiem



powłoka dichroiczna odbijająca wiązkę świetlną od przodu, a promieniowanie ciepłe do tyłu lamp









trzonek G4/G5,3



TRWAŁOŚĆ ► 2000h

LIFE ► 2000h
LEBENSDAUER ► 2000h
СРОК СЛУЖБЫ ► 2000 ч
Životnost ► 2000h

						
kod	symbol	EAN	opakowanie	moc [W]	kąt	światłość [cd]
D05-MR11-1030	MR11-1030	5908311360316	10/200	10	30°	280
D05-MR11-2030	MR11-2030	5908311360323	10/200	20	30°	550
D05-MR11-3530	MR11-3530	5908311360330	10/200	35	30°	850
D05-MR16-2060	MR16-2060	5908311360347	10/200	20	60°	300
D05-MR16-3560	MR16-3560	5908311360354	10/200	35	60°	640
D05-MR16-5060	MR16-5060	5908311360361	10/200	50	60°	780
D05-AR111-35W	AR111-35W	5900280910219	1/10	35	45°	600
D05-AR111-50W	AR111-50W	5900280910226	1/10	50	45°	1200

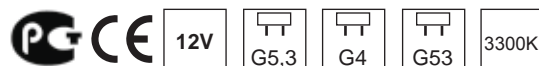
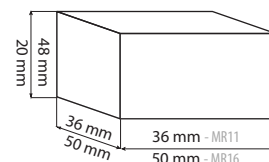
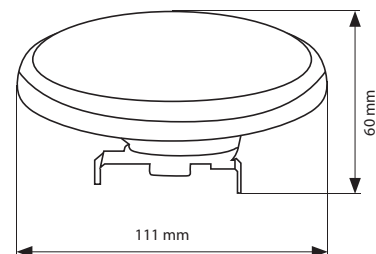
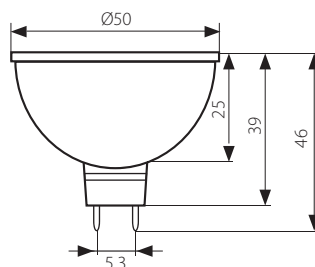
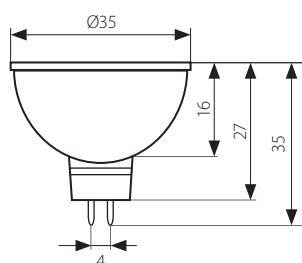

ŻARNIK HALOGENOWY LINIOWY 230V

HALOGEN LIGHTING SOURCES 230V
 HALOGENGLÜHLAMPE 230V
 ГАЛОГЕННАЯ ЛАМПА 230В
 LINEÁRNÍ HALOGEN 230V



Trzonek Rx7s



do montażu w oprawach FLA, SFL, PFL



żarniki halogenowe o długości 78
 oraz 118mm

J118-500









J078-60



TRWAŁOŚĆ ► 2000H

LIFE ► 2000H
 LEBENSDAUER ► 2000H
 СРОК СЛУЖБЫ ► 2000 Ч
 ŽIVOTNOST ► 2000H

					
kod	symbol	EAN	opakowanie	moc [W]	strumień świetlny [lm]
D10-J078-060	J078-60	5908311360378	50/500	60	550
D10-J078-100	J078-100	5908311360385	50/500	100	1100
D10-J078-150	J078-150	5908311360392	50/500	150	1800
D10-J118-100	J118-100	5908311360408	50/500	100	1050
D10-J118-150	J118-150	5908311360415	50/500	150	1800
D10-J118-200	J118-200	5908311360422	50/500	200	2400
D10-J118-300	J118-300	5908311360439	50/500	300	4000
D10-J118-500	J118-500	5908311360446	50/500	500	8000

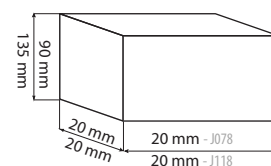
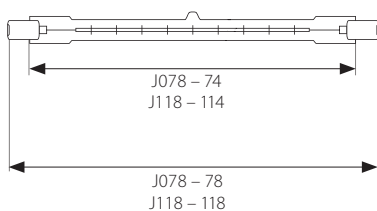

HALOGEN LIGHTING SOURCES 230V
 HALOGENGLÜHLAMPE 230V
 ГАЛОГЕННАЯ ЛАМПА 230В
 HALOGENOVÁ ŽÁROVKA 230V



bańka z żarnikiem



trzonek G9, zasilanie 230V AC

JD-G9



TRWAŁOŚĆ ► 2000H
 LIFE ► 2000H
 LEBENSDAUER ► 2000H
 СРОК СЛУЖБЫ ► 2000 Ч
 ŽIVOTNOST ► 2000H

kod	symbol	EAN	opakowanie	moc [W]	strumień świetlny [lm]
D15-JDG9-20C	JD-G9-20C	5908311360491	100/1000	20	200
D15-JDG9-35C	JD-G9-35C	5908311360507	100/1000	35	390
D15-JDG9-40C	JD-G9-40C	5908311360514	100/1000	40	465
D15-JDG9-50C	JD-G9-50C	5908311360521	100/1000	50	540

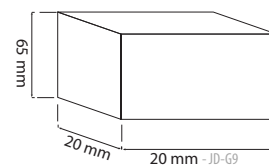
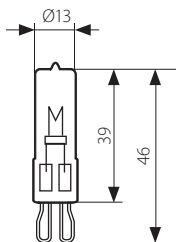

HALOGEN LIGHTING SOURCES 230V
 HALOGENGLÜHLAMPE 230V
 ГАЛОГЕННАЯ ЛАМПА 230В
 DICHROICKÝ HALOGEN 230V



widok wnętrza lampy ze szklanym odbłyśnikiem



powłoka dichroiczna odbijająca wiązkę świetlną od przodu, a promieniowanie ciepłe do tyłu lampy



trzonek G5,3

JCDR-20









TRWAŁOŚĆ ► 2000h

LIFE ► 2000h

LEBENSDAUER ► 2000h

СРОК СЛУЖБЫ ► 2000 ч

Životnost ► 2000h

					
kod	symbol	EAN	opakowanie	moc [W]	światłość [cd]
D20-JCDR-20-38	JCDR-20	5908311360538	10/200	20	360
D20-JCDR-35-38	JCDR-35	5908311360545	10/200	35	580
D20-JCDR-50-38	JCDR-50	5908311360552	10/200	50	800

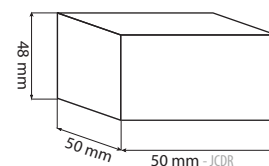
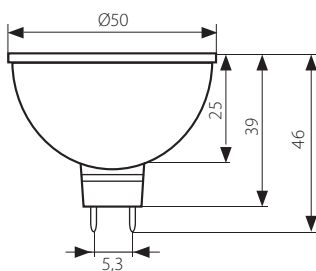

HALOGEN LIGHTING SOURCES 230V
 HALOGENGLÜHLAMPE 230V
 ГАЛОГЕННАЯ ЛАМПА 230В
 DICHROICKÝ HALOGEN 230V



widok wnętrza lampy ze szklanym odbłyśnikiem



powłoka dichroiczna odbijająca wiązkę świetlną od przodu, a promieniowanie ciepłe do tyłu lampy



trzonek GU10 jako łącznik ze źródłem zasilania

JDR-20



TRWAŁOŚĆ ▶ 2000h

LIFE ▶ 2000h
 LEBENSDAUER ▶ 2000h
 СРОК СЛУЖБЫ ▶ 2000 ч
 Životnost ▶ 2000h

kod	symbol	EAN	opakowanie	moc [W]	światłość [cd]
D20-JDR-20-38	JDR-20-38	5908311360569	10/200	20	360
D20-JDR-35-38	JDR-35-38	5908311360576	10/200	35	580
D20-JDR-50-38	JDR-50-38	5908311360583	10/200	50	800

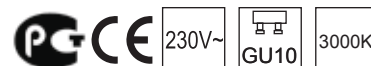
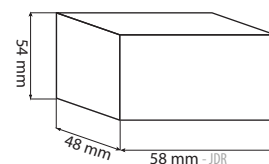
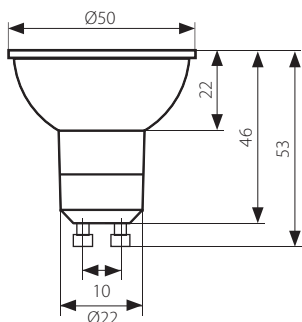

METAL-HALIDE LAMPS
 HALOGEN-METALLDAMPFLAMPE
 ЛАМПА МЕТАЛЛОГАЛОГЕННАЯ
 METALHALOGENIDOVÁ VÝBOJKA



trzonek Rx7s, lampa MH średniej mocy



jarznik kwarcowy zawierający elektrody zapłonową (MH150)



trzonek E40



barwa 4000K



pozycja pracy dowolna



jarznik kwarcowy w lampie MH-250, MH-400



lampy wymagają układu zapłonowego

MH-150W



MH-250



TRWAŁOŚĆ ► 8000h

LIFE ► 8000h
 LEBENSDAUER ► 8000h
 СРОК СЛУЖБЫ ► 8000 ч
 ŽIVOTNOST ► 8000h

kod	symbol	EAN	opakowanie	moc [W]	trzonek	strumień świetlny [lm]	prąd pracy lampy MH [A]
D30-MH070-R7S	MH-70	5908311360200	1/10/100	70	Rx7s	6 900	0,89
D30-MH150-R7S	MH-150	5908311360217	1/10/100	150	Rx7s	15 000	1,80
D30-MH250-E40	MH-250	5908311360224	1/25	250	E40	19 000	2,10
D30-MH400-E40	MH-400	5908311360231	1/25	400	E40	40 000	3,40

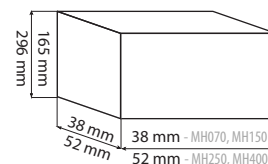
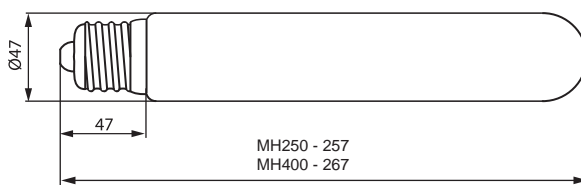
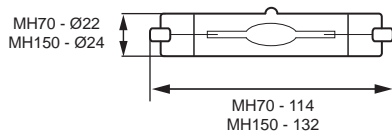

SODIUM LAMPS
NATRIUMDAMPFLAMPE
НАТРИЕВАЯ ЛАМПА
SODÍKOVÁ VÝBOJKA



trzonek E27/E40



temperatura barwowa 2000K



jarznik wysokoprężnej lampy sodowej



lampa wymagają układu zapłonowego











TRWAŁOŚĆ ► 12000h

LIFE ► 12000h

LEBENSDAUER ► 12000h

СРОК СЛУЖБЫ ► 12000 ч

ŽIVOTNOST ► 12000h

							
kod	symbol	EAN	opakowanie	trzonek	moc [W]	strumień świetlny [lm]	prąd pracy lampy [A]
D40-T38-070	T38-070	5908311363539	1/50	E27	70	6 000	0,98
D40-T38-150	T38-150	5908311363546	1/50	E27	150	15 000	1,80
D40-T46-150	T46-150	5908311363867	1/25	E40	150	15 000	1,80
D40-T46-250	T46-250	5908311363553	1/25	E40	250	28 000	2,10
D40-T46-400	T46-400	5908311363560	1/25	E40	400	48 000	4,60

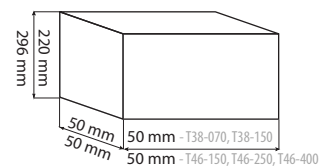
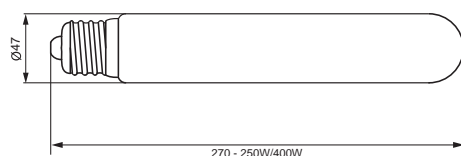
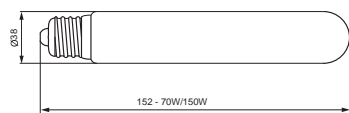

FLUORESCENT LAMP T4, T5
LEUCHSTOFFLAMPE T4, T5
ЛЮМИНЕСЦЕНТНАЯ ЛАМПА T4, T5
LINEÁRNÍ ZÁŘIVKA - ZÁŘIVKOVÁ TRUBICE T4, T5



trzonek G5 modeli T4 oraz T5



temperatura barwowa: 2700K lub 4000K



T4-08-27









T5-28-40

TRWAŁOŚĆ T5 ▶ 15000h

LIFE T5 ▶ 15000h
LEBENSDAUER T5 ▶ 15000h
СРОК СЛУЖБЫ T5 ▶ 15000 ч
ŽIVOTNOST T5 ▶ 15000h

TRWAŁOŚĆ T4 ▶ 5000h

LIFE T4 ▶ 5000h
LEBENSDAUER T4 ▶ 5000h
СРОК СЛУЖБЫ T4 ▶ 5000 ч
ŽIVOTNOST T4 ▶ 5000h

							
kod	symbol	EAN	opakowanie	moc [W]	temperatura barwowa [K]	strumień świetlny [lm]	∅
D50-T4-08-27	T4-08-27	5900280902368	1/40	8	2700	650	340mm, 12mm
D50-T4-08-40	T4-08-40	5900280902351	1/40	8	4000	650	340mm, 12mm
D50-T4-12-27	T4-12-27	5900280902382	1/40	12	2700	730	366mm, 12mm
D50-T4-12-40	T4-12-40	5900280902375	1/40	12	4000	730	366mm, 12mm
D50-T4-16-27	T4-16-27	5900280902405	1/40	16	2700	1020	466mm, 12mm
D50-T4-16-40	T4-16-40	5900280902399	1/40	16	4000	1020	466mm, 12mm
D50-T4-20-27	T4-20-27	5900280902429	1/40	20	2700	1200	566mm, 12mm
D50-T4-20-40	T4-20-40	5900280902412	1/40	20	4000	1200	566mm, 12mm
D50-T5-08-27	T5-08-27	5908311363577	1/100	8	2700	480	207mm, 16mm
D50-T5-08-40	T5-08-40	5908311363584	1/100	8	4000	480	207mm, 16mm
D50-T5-13-27	T5-13-27	5908311363591	1/100	13	2700	1020	515mm, 16mm
D50-T5-13-40	T5-13-40	5908311363607	1/100	13	4000	1020	515mm, 16mm
D50-T5-14-27	T5-14-27	5908311364864	1/50	14	2700	1080	547mm, 16mm
D50-T5-14-40	T5-14-40	5908311364871	1/50	14	4000	1080	547mm, 16mm
D50-T5-21-27	T5-21-27	5908311363614	1/40	21	2700	1800	847mm, 16mm
D50-T5-21-40	T5-21-40	5908311363621	1/40	21	4000	1800	847mm, 16mm
D50-T5-28-27	T5-28-27	5908311364888	1/50	28	2700	2500	1150mm, 16mm
D50-T5-28-40	T5-28-40	5908311364895	1/50	28	4000	2500	1150mm, 16mm

COMPACT FLUORESCENT BULB
LEUCHTSTOFFLAMPE
ЭНЕРГОСБЕРЕГАЮЩАЯ ЛАМПА
KOMPAKTNÍ ZÁŘIVKA



BLC - trzonek G24D (2 piny)



trzonki BLC: G24D-1 model 13W,
G24D-2 model 18W, G24D-3 model
26W



modele BLC świetlówka typu 2U



BLS - trzonek G23 (2 piny)



modele BLS świetlówka typ 1U

BLS-07-G23



BLC-13-G24D



BLS-11-G23

BLC-26-G24D

kod	symbol	EAN	opakowanie zbiorcze	trzonek	barwa światła [K]	moc [W]	strumień świetlny [lm]
D52-BLC-13-G24D	BLC-13-G24D	5908311363935	10/50	G24D-1	4000	13	670
D52-BLC-18-G24D	BLC-18-G24D	5908311363942	10/50	G24D-2	4000	18	1090
D52-BLC-26-G24D	BLC-26-G24D	5908311363959	10/50	G24D-3	4000	26	1600
D52-BLS-07-G23	BLS-07-G23	5908311363966	10/50	G23	4000	7	310
D52-BLS-09-G23	BLS-09-G23	5908311363973	10/50	G23	4000	9	410
D52-BLS-11-G23	BLS-11-G23	5908311363980	10/50	G23	4000	11	570

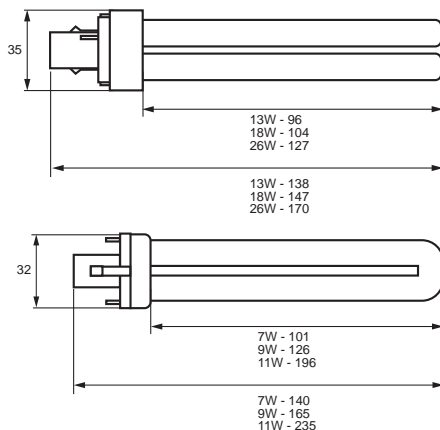

x / y / z
BLC-13 – 35/140/35
BLC-18 – 35/175/35
BLC-26 – 35/175/35
BLS-07 – 32/140/20
BLS-09 – 32/175/20
BLS-11 – 32/175/20

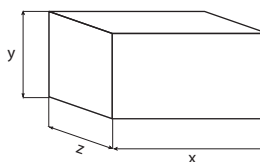

COMPACT FLUORESCENT BULB
LEUCHTSTOFFLAMPE
ЛЮМИНЕСЦЕНТНАЯ ЛАМПА
KOMPAKTNÍ ZÁŘIVKA



trzonek E14











trzonek E27



HLS-T2-3-E27



HLS-T2-3-E14

							
kod	symbol	EAN	opakowanie	trzonek	barwa światła [K]	moc [W]	strumień świetlny [lm]
D55-HLS-T2-3-E14-11W	HLS-T2-3-E14-11	5908311364024	10/50	E14	2 700	11	515
D55-HLS-T2-3-E27-11W	HLS-T2-3-E27-11	5908311364031	10/50	E27	2 700	11	515

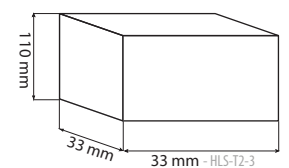
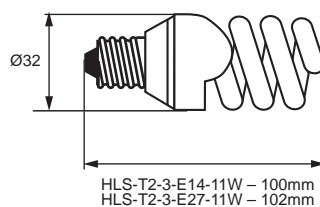

COMPACT FLUORESCENT BULB
LEUCHTSTOFFLAMPE
ЛЮМИНЕСЦЕНТНАЯ ЛАМПА
KOMPAKTNÍ ZÁŘIVKA T2



trzonek E27



model half spiral, typ T2-6



rura T2, średnica 7,5mm



kod	symbol	EAN	opakowanie	trzonek	barwa światła [K]	moc [W]	strumień świetlny [lm]
D55-HLS-T2-6-E27-15W	HLS-T2-6-E27-15	5908311364048	10/50	E27	2 700	15	800
D55-HLS-T2-6-E27-20W	HLS-T2-6-E27-20	5908311364055	10/50	E27	2 700	20	1155
D55-HLS-T2-6-E27-24W	HLS-T2-6-E27-24	5908311364062	10/50	E27	2 700	24	1445

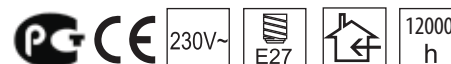
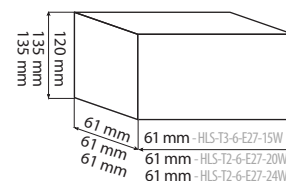
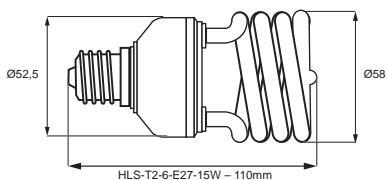
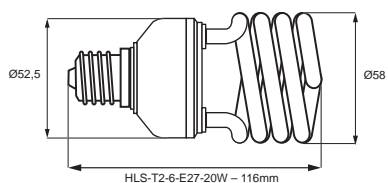
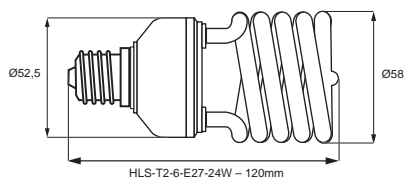

COMPACT FLUORESCENT BULB
LEUCHTSTOFFLAMPE
ЛЮМИНЕСЦЕНТНАЯ ЛАМПА
KOMPACTNÍ ZÁŘIVKA



trzonek E27



model full spiral, typ T3-11, średnica rury 10mm











model full spiral, typ T4-6

HLS-T4-6-E27-55



HLS-T3-11-E27-35

							
kod	symbol	EAN	opakowanie	trzonek	barwa światła [K]	moc [W]	strumień świetlny [lm]
D55-HLS-T3-11-E27-35W	HLS-T3-11-E27-35	5900280904768	1/10/50	E27	2.700	35	2450
D55-HLS-T4-6-E27-55W	HLS-T4-6-E27-55	5900280904775	1/5/25	E27	2.700	55	3850

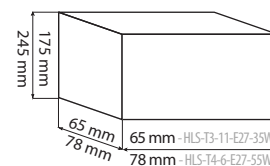

COMPACT FLUORESCENT BULB
LEUCHTSTOFFLAMPE
ЛЮМИНЕСЦЕНТНАЯ ЛАМПА
KOMPACTNÍ ZÁŘIVKA T6



obudowa specjalnej konstrukcji odprowadzająca ciepło



trzonek E27/E40



model full spiral, typ T6-2



wbudowany układ zapłonowy



średnica rury 16,5mm



HLS 75W E40 w oprawie NA250-400



HLS-T6-2-E40-75W

kod	symbol	EAN	opakowanie	trzonek	barwa światła [K]	moc [W]	strumień świetlny [lm]
D55-HLS-T6-2-E27-75W	HLS-T6-2-E27-75	5908311364840	1/5/25	E27	2 700	75	5180
D55-HLS-T6-2-E40-75W	HLS-T6-2-E40-75	5908311364857	1/5/25	E40	2 700	75	5180

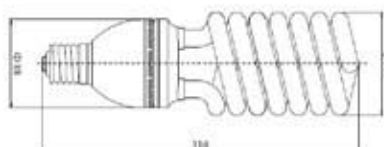

HLS-T6-2-E27-75

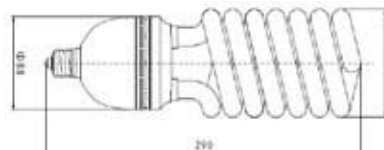

HLS-T6-2-E40-75

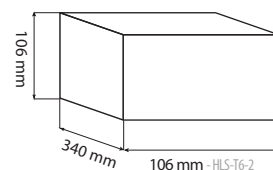

106 mm - HLS-T6-2

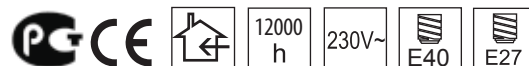

LED LAMPS - G
LED-BIRNE
ΛΑΜΠΑ LED - G
SVĚTELNÉ ZDROJE LED - G



diody SMD 5050, zasilanie 12V AC



trzonek typu G4



dioda w barwie 2700K, moc 0.3W

G4-SMD12-WW-FLAT-12V



D80-G9-2.5W-WW-SILC



D80-G4-3W-WW-SILC



kod	symbol	EAN	opakowanie zbiorcze	barwa światła [K]	strumień światła [lm]	moc [W]	liczba LED	kąt rozsyłu [°]	napięcie [V]
D81-G4-SMD12-WW-FLAT	G4-SMD12-WW-FLAT	5908311363744	1/10/1000	3000	180	2,2	12	120	12
D80-G4-3W-WW-SILC	G4-3W-WW-SILC	5908311364093	1/10/1000	3000	170	2,8	57	360	12
D80-G9-2.5W-WW-SILC	G9-2.5W-WW-SILC	5900280904621	1/10/1000	3000	225	3,5	64	360	230

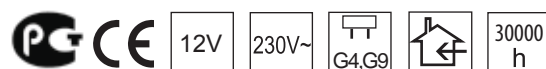
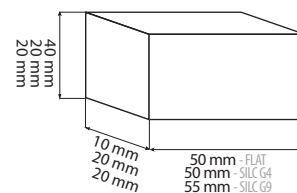
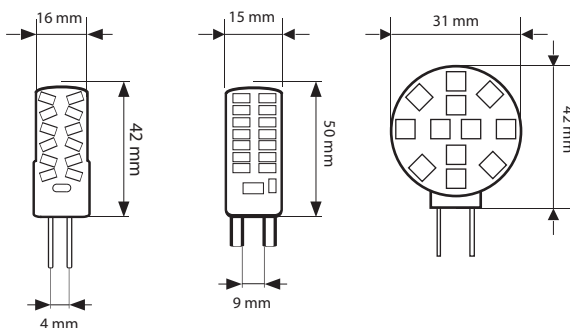

LED LAMPS – GU10
 LED-BIRNE – GU10
 ΛΑΜΠΑ LED – GU10
 SVĚTELNÉ ZDROJE LED – GU10



trzonek GU10



obudowa aluminiowa

diody SMD5630 w modelach
barwa ciepła

GU10-4W-240LM-WW



GU10-4.5W-320LM-WW



GU10-SMD24-WW-GL



Kod	Symbol	EAN	Opakowanie zbiorcze	Barwa światła [K]	Strumień świetlny [lm]	Moc [W]	Liczba led	Kąt rozsyłu [°]
D82-GU10-04W-240LM-WW	GU10-04W-240LM-WW	5900280904553	1/10/200	2700	240	4,0	27	120
D82-GU10-04.5W-320LM-WW	GU10-04.5W-320LM-WW	5900280905581	1/10/200	2700	320	4,5	27	120
D82-GU10-SMD24-WW-GL	GU10-SMD24-WW-GL	5900280904553	1/10/200	3000	280	4,0	24	120

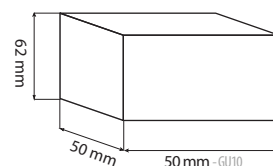
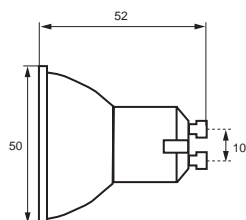

LED LAMPS – E14
 LED-BIRNE – E14
 ΛΑΜΠΑ LED – E14
 SVĚTELNÉ ZDROJE LED – E14



gwint E14



podstawa ceramiczna









klosz mleczny



E14-04W-C37-WW



E14-04W-G45-WW

								
kod	symbol	EAN	opakowanie zbiorcze	barwa światła [K]	trzonek	strumień światła [lm]	moc [W]	liczba LED
D84-E14-04W-C37-WW	E14-04W-C37-WW	5900280907257	1/10/100	2700	E14	400	4	12
D84-E14-04W-G45-WW	E14-04W-G45-WW	5900280907264	1/10/100	2700	E14	400	4	12

37 mm - E14-04W-C37

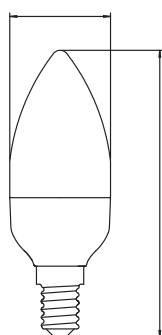

110 mm

45 mm - E14-04W-G45-WW

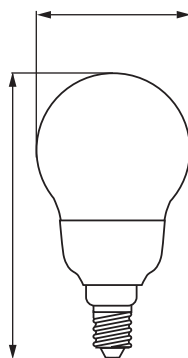

85 mm



LED LAMPS - E27
LED-BIRNE - E27
ΛΑΜΠΑ LED - E27
SVĚTELNÉ ZDROJE LED - E27



tradycyjny trzonek E27



klosz mleczny, barwa 3000K

E27-A60-06W-WW



E27-A60-12W-WW











E27-A60-10W-WW



E27-04W-G45-WW



								
kod	symbol	EAN	opakowanie zbiorcze	barwa światła [K]	trzonek	strumień światła [lm]	moc [W]	liczba LED
D85-E27-A60-06W-WW	E27-A60-06W-WW	5900280906489	1/10/100	3000	E27	500	6	26
D85-E27-A60-10W-WW	E27-A60-10W-WW	5900280904904	1/10/100	3000	E27	800	10	8
D85-E27-A65-12W-WW	E27-A65-12W-WW	5900280907288	1/10/100	3000	E27	1055	12	55
D85-E27-04W-G45-WW	E27-04W-G45-WW	5900280904911	1/10/100	2700	E27	400	4	12

60mm - E27-A60-06W-WW
60mm - E27-A60-10W-WW
65mm - E27-A65-12W-WW

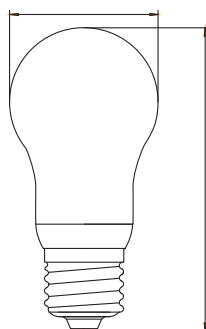

110mm - E27-A60-06W-WW
115mm - E27-A60-10W-WW
125mm - E27-A65-12W-WW

45mm - E27-04W-G45-WW

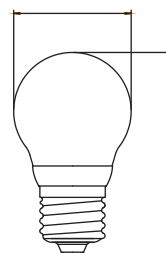

83mm - E27-04W-G45-WW



LED TUBE
LED-TUBE
СВЕТОДИОДНЫЕ ТРУБКИ
LED TRUBICE



trzonek T8









klosz mleczny wykonany z PVC



zasilanie jednostronne 230V/50Hz,
oznaczone naklejką



T8-LED

					
kod	symbol	EAN	opakowanie zbiorcze	barwa światła [K]	Długość [cm]
D891-T8-LED060-40	T8-LED060-40	5900280901989	1	4000	60
D891-T8-LED060-60	T8-LED060-60	5900280910172	1	6000	60
D891-T8-LED120-40	T8-LED120-40	8900280910189	1	4000	60
D891-T8-LED120-60	T8-LED120-60	5900280910196	1	6000	120
D891-T8-LED150-40	T8-LED150-40	5900280901996	1	4000	120
D891-T8-LED150-60	T8-LED150-60	5900280910202	1	6000	120

LED STRIP LIGHTS
LED-STREIFEN
СВЕТОДИОДНЫЕ ЛЕНТЫ
LED PÁSKY



5 metrowe rolki



możliwość dzielenia co 5cm



zasilanie 12V DC











modele hermetyczne LED-07, LED-08



model LED-06 z IP20



									IP
kod	symbol	EAN	opakowanie	barwa światła [K]	moc [W]	liczba LED	długość taśmy [cm]	możliwość cięcia	IP
D87-LED-06-500-3000K	LED-06-500-3000K	5900280901644	1/50	3000	24	60 na metr	500	tak, co 5 cm	40
D87-LED-06-500-6000K	LED-06-500-6000K	5900280901651	1/50	6000	24	60 na metr	500	tak, co 5 cm	40
D87-LED-07-500-3000K	LED-07-500-3000K	5900280901668	1/50	3000	24	60 na metr	500	tak, co 5 cm	65
D87-LED-07-500-6000K	LED-07-500-6000K	5900280901675	1/50	6000	24	60 na metr	500	tak, co 5 cm	65